



HTMF



Multifunctional 400°C/2h and 300°C/2h roof fans

Multifunctional 400°C/2h ceiling fans to work inside fire danger zones, designed for smoke extraction in industrial or similar buildings.

Fan:

- Sheet steel base plate.
- Turnable impellers cast aluminium.
- Protection guard to prevent contacts according to standard UNE-EN ISO 12499:2010
- Sheet steel hood with natural air outlet. Approval according to Standard EN 12101-3:2002/AC:2006, with certification No 0370-CPR-0544

Motor:

- Class H motors, ongoing use S1 and emergency use S2, with ball bearings, IP55 protection, and one- or two- speed depending on the model.
- Three-phase 230/400V -50Hz. (up to 4HP) and 400/690V.-50Hz. (power over 4HP)
- Max. air temperature to transport: S1 Service -20°C + 40°C for ongoing use, S2 Service 300°C/2h, 400°C/2h

Finish:

- Anti-corrosive finish in polyester resin, polymerised at 190°C after phosphate free pre-treatment

On request:

- Fans with 200°C/2h one- or two-speed motor

Order code

HTMF — 56 — 4T — 2 — F-400

HTMF: Multifunctional 400°C/2h and 300°C/2h roof fans

Impeller diameter in cm.

Number of motor pole
 T=Three-phase
 2=2900 r/min. 50 Hz
 4=1400 r/min. 50 Hz
 6=900 r/min. 50 Hz
 8=750 r/min. 50 Hz
 12=500 r/min. 50 Hz

Motor power (HP)

F-300 Officially approved, tested for 300°C/2h
 F-400 Officially approved 400°C/2h

Technical characteristics

Model	Speed (r/min)	Maximum admissible current (A)			Power installed (kW)	Airflow maximum (m³/h)	Sound pressure (1) level dB(A)		Approx. weight (Kg)
		230V	400V	690V			Inlet	Outlet	
HTMF-56-4T-1	1430	3,80	2,20		0,75	10545	62	59	79
HTMF-56-4T-1,5	1420	4,70	2,70		1,10	11400	63	60	79
HTMF-56-4/8T-1,5	1440/710		2,90 / 1,40		1,10/0,25	11400 / 5700	63 / 48	60 / 45	79
HTMF-56-6T-0,75	930	3,30	1,90		0,55	8170	51	49	80
HTMF-63-4T-1,5	1420	4,70	2,70		1,10	13870	65	62	94
HTMF-63-4/8T-1,5	1440/710		2,90 / 1,40		1,10/0,25	13870 / 6935	65 / 50	62 / 47	94
HTMF-63-4T-2	1425	6,60	3,80		1,50	15485	66	63	96
HTMF-63-4/8T-2	1415/715		3,60 / 1,50		1,50/0,30	15485 / 7742	66 / 51	63 / 48	106
HTMF-63-4T-3	1435	9,20	5,30		2,20	17955	67	64	108
HTMF-63-4/8T-3	1415/715		5,20 / 1,90		2,20/0,45	17955 / 8977	67 / 52	64 / 49	112
HTMF-63-6T-0,75	930	3,30	1,90		0,55	10260	56	54	95
HTMF-63-6T-1	940	4,40	2,60		0,75	11305	57	55	95
HTMF-71-4T-2	1425	6,60	3,80		1,50	16150	69	66	109
HTMF-71-4/8T-2	1415/715		3,60 / 1,50		1,50/0,30	16150 / 8075	69 / 54	66 / 51	119
HTMF-71-4T-3	1435	9,20	5,30		2,20	18430	71	68	122
HTMF-71-4/8T-3	1415/715		5,20 / 1,90		2,20/0,45	18430 / 9215	71 / 56	68 / 53	125
HTMF-71-4T-4	1430	11,40	6,60		3,00	22610	72	69	133
HTMF-71-4/8T-4	1420/705		6,90 / 2,30		3,00/0,60	22610 / 11305	72 / 57	69 / 54	135
HTMF-71-6T-1	940	4,40	2,60		0,75	13205	58	56	109

Technical characteristics

Model	Speed (r/min)	Maximum admissible current (A)			Power installed (kW)	Airflow maximum (m³/h)	Sound pressure (1) level dB(A)		Approx. weight (Kg)
		230V	400V	690V			Inlet	Outlet	
HTMF-71-6T-1,5	945	6,40	3,70		1,10	16245	59	57	116
HTMF-80-4T-4	1430	11,40	6,60		3,00	27600	73	70	163
HTMF-80-4/8T-4	1420/705		6,90 / 2,30		3,00/0,60	27600 / 13800	73 / 58	70 / 55	165
HTMF-80-4T-5,5	1440		8,40	4,85	4,00	30176	74	71	163
HTMF-80-4/8T-5,5	1450/720		9,40 / 3,50		4,00/0,80	30176 / 15088	74 / 59	71 / 56	195
HTMF-80-6T-1,5	945	6,40	3,70		1,10	19412	62	60	145
HTMF-80-6T-2	945	7,40	4,30		1,50	22172	63	61	148
HTMF-80-6T-3	950	10,30	5,90		2,20	24932	64	62	160
HTMF-80-8T-1	710	4,80	2,80		0,75	16376	61	60	151
HTMF-90-4T-5,5	1440		8,40	4,85	4,00	35052	79	76	208
HTMF-90-4/8T-5,5	1450/720		9,40 / 3,50		4,00/0,80	35052 / 17526	79 / 64	76 / 61	238
HTMF-90-4T-7,5	1430		11,50	6,64	5,50	38456	81	78	240
HTMF-90-4/8T-7,5	1455/725		12,80 / 4,60		5,50/1,10	38456 / 19228	81 / 66	78 / 63	243
HTMF-90-4T-10	1460		17,70	10,22	7,50	41308	82	79	244
HTMF-90-4/8T-9	1455/725		15,50 / 5,50		6,70/1,50	41308 / 20654	82 / 67	79 / 64	243
HTMF-90-6T-3	950	10,30	5,90		2,20	29256	68	66	205
HTMF-90-6/12T-3	940/470		5,60 / 2,20		2,20/0,37	29256 / 14628	68 / 53	66 / 51	245
HTMF-90-6T-4	945	15,00	8,70		3,00	32016	69	67	235
HTMF-90-6/12T-4	970/475		8,90 / 3,50		3,00/0,55	32016 / 16008	69 / 54	67 / 52	245
HTMF-90-8T-1	710	4,80	2,80		0,75	17020	61	60	196
HTMF-90-8T-2	700	9,00	5,20		1,50	19596	63	62	208
HTMF-100-4T-7,5	1430		11,50	6,64	5,50	40756	84	81	265
HTMF-100-4/8T-7,5	1455/725		12,80 / 4,60		5,50/1,10	40756 / 20378	84 / 69	81 / 66	269
HTMF-100-4T-10	1460		17,70	10,22	7,50	47564	85	82	269
HTMF-100-4/8T-9	1455/725		15,50 / 5,50		6,70/1,50	44528 / 22264	84 / 69	81 / 66	269
HTMF-100-4T-15	1455		23,00	13,28	11,00	51336	86	83	332
HTMF-100-4/8T-14	1470/725		23,20 / 8,70		11,00/2,80	48300 / 24150	85 / 70	82 / 67	301
HTMF-100-6T-3	950	10,30	5,90		2,20	32476	74	72	231
HTMF-100-6/12T-3	940/470		5,60 / 2,20		2,20/0,37	32476 / 16238	74 / 59	72 / 57	271
HTMF-100-6T-4	945	15,00	8,70		3,00	35420	75	73	260
HTMF-100-6/12T-4	970/475		8,90 / 3,50		3,00/0,55	35420 / 17710	75 / 60	73 / 58	271
HTMF-100-6T-5,5	970		11,00	6,35	4,00	40020	76	74	277
HTMF-100-6/12T-5,5	970/480		11,30 / 4,20		4,00/0,65	40020 / 20010	76 / 61	74 / 59	289
HTMF-100-8T-3	705	13,20	7,60		2,20	26404	69	68	260
HTMF-100-8T-4	710	15,60	9,00		3,00	28704	70	69	270
HTMF-THT-125-4T/3-10	1460		13,90	8,06	7,50	55250	75	72	330
HTMF-THT-125-4T/3-15	1470		20,90	12,10	11,00	72150	76	73	369
HTMF-THT-125-4T/3-20	1465		27,90	16,20	15,00	83120	78	75	391
HTMF-THT-125-4T/6-15	1470		20,90	12,10	11,00	66800	76	73	384
HTMF-THT-125-4T/6-20	1465		27,90	16,20	15,00	72900	76	73	406
HTMF-THT-125-4T/9-20	1465		27,90	16,20	15,00	76310	75	72	422
HTMF-THT-125-6T/6-5,5	970		11,00	6,35	4,00	47760	63	61	341
HTMF-THT-125-6T/6-7,5	970		14,00	8,08	5,50	55600	63	61	341
HTMF-THT-125-6T/6-10	975		14,80	8,58	7,50	66170	65	63	389
HTMF-THT-125-6T/6-15	975		21,90	12,70	11,00	76380	67	65	411
HTMF-THT-125-6T/9-7,5	970		14,00	8,08	5,50	50000	64	62	357
HTMF-THT-125-6T/9-10	975		14,80	8,58	7,50	59340	64	62	405
HTMF-THT-125-6T/9-15	975		21,90	12,70	11,00	71890	67	65	427
HTMF-THT-125-6T/9-20	975		28,20	16,30	15,00	83660	70	68	422
HTMF-THT-125-8T/6-4	710	15,60	9,00		3,00	47510	56	55	346
HTMF-THT-125-8T/6-5,5	710		13,00	7,51	4,00	52770	58	57	385
HTMF-THT-125-8T/6-7,5	710		15,10	8,72	5,50	60410	60	59	394
HTMF-THT-125-8T/6-10	715		20,60	11,89	7,50	66030	61	60	416
HTMF-THT-125-8T/9-5,5	710		13,00	7,51	4,00	51330	58	57	401
HTMF-THT-125-8T/9-7,5	710		15,10	8,72	5,50	54480	61	60	410
HTMF-THT-125-8T/9-10	715		20,60	11,89	11,00	65660	64	63	432
HTMF-THT-125-8T/9-15	725		21,70	12,53	7,50	73870	63	62	472

(1) The sound level values are free field measurements of pressure in dB(A) at a distance of 6 m.



Erp. BEP (best efficiency point) characteristics

<(°)	Angle of inclination of the blades, in degrees	SR	Specific ratio
PN	Motor's nominal power in kW	ηe[%]	Efficiency
MC	Measurement category	N	Efficiency grade
EC	Efficiency category	[kW]	Input power
S	Static	[m³/h]	Airflow
T	Total	[mmH²O]	Static or total pressure (According to EC)
VSD	Variable-speed drive	[RPM]	Speed

Model	MC	EC	VSD	SR	ηe[%]	N	(kW)	(m³/h)	(mmH₂O)	(RPM)
HTMF-56-4T-1	C	S	NO	1,00	35,4%	38,2	0,85	7901	14,07	1443
HTMF-56-4T-1,5	B	T	NO	1,00	48,5%	49,7	1,16	11340	18,14	1438
HTMF-56-4/8T-1,5	B	T	NO	1,00	44,9%	46,9	1,33	11588	18,94	1449
HTMF-56-6T-0,75	B	T	NO	1,00	42,7%	45,4	0,52	9212	8,77	955
HTMF-63-4T-1,5	C	S	NO	1,00	48,2%	49,6	1,11	10387	18,88	1440
HTMF-63-4/8T-1,5	C	S	NO	1,00	41,3%	46,6	1,38	10605	19,68	1447
HTMF-63-4T-2	C	S	NO	1,00	42,4%	41,9	1,54	12016	20,00	1444
HTMF-63-4/8T-2	C	S	NO	1,00	37,2%	41,7	1,70	11892	19,59	1430
HTMF-63-4T-3	B	T	NO	1,00	62,4%	62,1	2,19	19423	25,86	1450
HTMF-63-4/8T-3	B	T	NO	1,00	56,0%	58,2	2,42	19373	25,73	1432
HTMF-63-6T-0,75	B	T	NO	1,00	56,1%	58,6	0,55	11393	9,86	956
HTMF-63-6T-1	B	T	NO	1,00	54,9%	55,3	0,80	13916	11,57	957
HTMF-71-4T-2	C	S	NO	1,00	48,5%	47,3	1,49	13409	19,84	1446
HTMF-71-4/8T-2	C	S	NO	1,00	42,6%	47,1	1,65	13275	19,45	1433
HTMF-71-4T-3	C	S	NO	1,00	44,7%	45,7	2,16	16356	21,67	1450
HTMF-71-4/8T-3	C	S	NO	1,00	40,1%	42,8	2,39	16314	21,56	1433
HTMF-71-4T-4	B	T	NO	1,00	68,4%	66,3	2,87	23676	30,48	1447
HTMF-71-4/8T-4	B	T	NO	1,00	61,6%	65,2	3,24	23797	30,80	1433
HTMF-71-6T-1	B	T	NO	1,00	62,4%	61,1	0,82	14945	12,60	957
HTMF-71-6T-1,5	B	T	NO	1,00	59,2%	59,1	1,15	18001	13,88	960
HTMF-80-4T-4	C	S	NO	1,00	46,9%	46,2	3,22	20108	27,62	1441
HTMF-80-4/8T-4	C	S	NO	1,00	42,3%	45,4	3,64	20222	27,93	1424
HTMF-80-4T-5,5	C	S	NO	1,00	45,5%	45,1	4,55	23694	32,11	1444
HTMF-80-4/8T-5,5	C	S	NO	1,00	43,3%	40,8	4,70	23552	31,72	1457
HTMF-80-6T-1,5	C	S	NO	1,00	38,9%	40,4	1,36	15261	12,68	953
HTMF-80-6T-2	B	T	NO	1,00	61,3%	61,4	1,85	24165	17,21	950
HTMF-80-6T-3	B	T	NO	1,00	64,9%	63,5	2,29	26615	20,53	960
HTMF-80-8T-1	B	T	NO	1,00	51,2%	56,4	1,13	18865	11,24	710
HTMF-90-4T-5,5	C	S	NO	1,00	51,0%	50,3	4,50	27512	30,65	1445
HTMF-90-4/8T-5,5	C	S	NO	1,00	48,6%	45,5	4,64	27348	30,28	1457
HTMF-90-4T-7,5	C	S	NO	1,00	47,8%	45,3	6,35	31725	35,17	1435
HTMF-90-4/8T-7,5	C	S	NO	1,00	43,0%	40,2	6,93	31525	34,73	1459
HTMF-90-4T-10	C	S	NO	1,01	45,4%	38,4	7,97	35188	37,75	1469
HTMF-90-4/8T-9	C	S	NO	1,00	43,0%	39,2	7,86	33548	36,97	1461
HTMF-90-6T-3	C	S	NO	1,00	42,8%	43,2	2,40	23147	16,33	958
HTMF-90-6/12T-3	C	S	NO	1,00	37,5%	41,4	2,64	22863	15,94	947
HTMF-90-6T-4	B	T	NO	1,00	63,7%	58,5	3,21	32972	22,77	957
HTMF-90-6/12T-4	B	T	NO	1,00	55,3%	57,4	3,70	32972	22,77	973
HTMF-90-8T-1	C	S	NO	1,00	36,4%	42,1	1,04	15838	8,76	713
HTMF-90-8T-2	B	T	NO	1,00	58,5%	55,4	1,40	24325	12,38	720
HTMF-100-4T-7,5	C	S	NO	1,00	50,5%	47,7	6,31	33024	35,42	1435
HTMF-100-4/8T-7,5	C	S	NO	1,00	45,4%	42,3	6,89	32817	34,98	1459
HTMF-100-4T-10	C	S	NO	1,00	48,1%	38,9	8,33	37734	39,02	1468
HTMF-100-4/8T-9	C	S	NO	1,00	45,8%	41,8	7,93	35548	37,50	1461
HTMF-100-4T-15	C	S	NO	1,01	44,1%	40,6	12,15	44732	43,97	1459
HTMF-100-4/8T-14	C	S	NO	1,01	39,0%	40,9	14,13	45164	44,82	1468
HTMF-100-6T-3	C	S	NO	1,00	45,4%	45,4	2,51	24808	16,87	956
HTMF-100-6/12T-3	C	S	NO	1,00	39,8%	43,6	2,75	24492	16,44	944
HTMF-100-6T-4	C	S	NO	1,00	41,1%	38,5	3,72	29458	19,07	950
HTMF-100-6/12T-4	C	S	NO	1,00	35,7%	38,1	4,29	29458	19,07	969
HTMF-100-6T-5,5	B	T	NO	1,00	61,3%	57,5	4,86	44005	24,89	972
HTMF-100-6/12T-5,5	B	T	NO	1,00	56,5%	55,4	5,44	44437	25,38	970
HTMF-100-8T-3	B	T	NO	1,00	52,5%	55,1	2,67	33957	15,20	710
HTMF-100-8T-4	B	T	NO	1,00	54,2%	55,3	2,77	41581	13,28	722
HTMF-THT-125-4T/3-10	C	S	NO	1,00	52,3%	53,2	7,59	41511	35,13	1468
HTMF-THT-125-4T/3-15	C	S	NO	1,01	56,1%	56,0	11,80	57655	42,19	1471
HTMF-THT-125-4T/3-20	C	S	NO	1,01	55,2%	54,9	15,29	67316	46,06	1472
HTMF-THT-125-4T/6-15	C	S	NO	1,01	57,8%	57,8	11,81	48508	51,71	1471
HTMF-THT-125-4T/6-20	C	S	NO	1,01	56,9%	56,7	14,20	52757	56,25	1474



Erp. BEP (best efficiency point) characteristics

Model	MC	EC	VSD	SR	ηe[%]	N	(kW)	(m³/h)	(mmH₂O)	(RPM)
HTMF-THT-125-4T/9-20	C	S	NO	1,01	70,4%	70,1	17,44	37304	120,90	1474
HTMF-THT-125-6T/6-5,5	C	S	NO	1,00	53,1%	55,5	4,28	34565	24,14	972
HTMF-THT-125-6T/6-7,5	C	S	NO	1,00	54,7%	56,3	5,53	41832	26,55	974
HTMF-THT-125-6T/6-10	C	S	NO	1,00	55,2%	55,9	7,84	53067	29,95	972
HTMF-THT-125-6T/6-15	C	S	NO	1,00	51,2%	51,2	11,09	61349	34,01	972
HTMF-THT-125-6T/9-7,5	C	S	NO	1,00	57,2%	58,8	5,67	36967	32,26	973
HTMF-THT-125-6T/9-10	C	S	NO	1,00	55,1%	56,2	6,74	48390	28,19	976
HTMF-THT-125-6T/9-15	C	S	NO	1,00	50,9%	50,9	11,00	61885	33,25	973
HTMF-THT-125-6T/9-20	C	S	NO	1,01	49,7%	49,5	15,00	69606	39,35	968
HTMF-THT-125-8T/6-4	C	S	NO	1,00	47,4%	50,3	3,53	38680	15,89	709
HTMF-THT-125-8T/6-5,5	C	S	NO	1,00	46,8%	49,1	4,42	42659	17,80	715
HTMF-THT-125-8T/6-7,5	C	S	NO	1,00	45,5%	47,0	5,87	50667	19,37	727
HTMF-THT-125-8T/6-10	B	T	NO	1,00	65,4%	66,1	7,79	65294	28,66	727
HTMF-THT-125-8T/9-5,5	C	S	NO	1,00	44,6%	46,7	4,79	43462	18,07	712
HTMF-THT-125-8T/9-7,5	C	S	NO	1,00	46,5%	48,0	5,75	48507	20,26	728
HTMF-THT-125-8T/9-10	C	S	NO	1,00	45,9%	46,7	7,65	55731	23,16	728
HTMF-THT-125-8T/9-15	B	T	NO	1,00	67,6%	67,6	10,90	72088	37,51	728

Internal fan data

Acoustic features

Values taken at inlet with maximum airflow.

Values taken at outlet with maximum airflow.

Sound power Lw(A) spectrum in dB(A) via frequency band in Hz.

Modelo	63	125	250	500	1000	2000	4000	8000	Modelo	63	125	250	500	1000	2000	4000	8000
56-4-1	46	67	74	79	82	78	71	60	56-4-1	43	64	71	76	79	75	68	57
56-4-1,5	47	68	75	80	83	79	72	61	56-4-1,5	44	65	72	77	80	76	69	58
56-6-0,75	35	56	63	68	71	67	60	49	56-6-0,75	33	54	61	66	69	65	58	47
56-8-1,5	32	53	60	65	68	64	57	46	56-8-1,5	29	50	57	62	65	61	54	43
63-4-1,5	49	70	77	82	85	81	74	63	63-4-1,5	46	67	74	79	82	78	71	60
63-4-2	50	71	78	83	86	82	75	64	63-4-2	47	68	75	80	83	79	72	61
63-4-3	51	72	79	84	87	83	76	65	63-4-3	48	69	76	81	84	80	73	62
63-6-0,75	40	61	68	73	76	72	65	54	63-6-0,75	38	59	66	71	74	70	63	52
63-6-1	41	62	69	74	77	73	66	55	63-6-1	39	60	67	72	75	71	64	53
63-8-1,5	34	55	62	67	70	66	59	48	63-8-1,5	31	52	59	64	67	63	56	45
63-8-2	35	56	63	68	71	67	60	49	63-8-2	32	53	60	65	68	64	57	46
63-8-3	36	57	64	69	72	68	61	50	63-8-3	33	54	61	66	69	65	58	47
71-4-2	53	74	81	86	89	85	78	67	71-4-2	50	71	78	83	86	82	75	64
71-4-3	55	76	83	88	91	87	80	69	71-4-3	52	73	80	85	88	84	77	66
71-4-4	56	77	84	89	92	88	81	70	71-4-4	53	74	81	86	89	85	78	67
71-6-1	42	63	70	75	78	74	67	56	71-6-1	40	61	68	73	76	72	65	54
71-6-1,5	43	64	71	76	79	75	68	57	71-6-1,5	41	62	69	74	77	73	66	55
71-8-2	38	59	66	71	74	70	63	52	71-8-2	35	56	63	68	71	67	60	49
71-8-3	40	61	68	73	76	72	65	54	71-8-3	37	58	65	70	73	69	62	51
71-8-4	41	62	69	74	77	73	66	55	71-8-4	38	59	66	71	74	70	63	52
80-4-4	57	78	85	90	93	89	82	71	80-4-4	54	75	82	87	90	86	79	68
80-4-5,5	58	79	86	91	94	90	83	72	80-4-5,5	55	76	83	88	91	87	80	69
80-6-1,5	46	67	74	79	82	78	71	60	80-6-1,5	44	65	72	77	80	76	69	58
80-6-2	47	68	75	80	83	79	72	61	80-6-2	45	66	73	78	81	77	70	59
80-6-3	48	69	76	81	84	80	73	62	80-6-3	46	67	74	79	82	78	71	60
80-8-1	45	66	73	78	81	77	70	59	80-8-1	44	65	72	77	80	76	69	58
80-8-4	42	63	70	75	78	74	67	56	80-8-4	39	60	67	72	75	71	64	53
80-8-5,5	43	64	71	76	79	75	68	57	80-8-5,5	40	61	68	73	76	72	65	54
90-4-5,5	63	84	91	96	99	95	88	77	90-4-5,5	60	81	88	93	96	92	85	74
90-4-7,5	65	86	93	98	101	97	90	79	90-4-7,5	62	83	90	95	98	94	87	76
90-4-9	66	87	94	99	102	98	91	80	90-4-9	63	84	91	96	99	95	88	77
90-4-10	66	87	94	99	102	98	91	80	90-4-10	63	84	91	96	99	95	88	77
90-6-3	52	73	80	85	88	84	77	66	90-6-3	50	71	78	83	86	82	75	64
90-6-4	53	74	81	86	89	85	78	67	90-6-4	51	72	79	84	87	83	76	65
90-8-1	45	66	73	78	81	77	70	59	90-8-1	44	65	72	77	80	76	69	58
90-8-2	47	68	75	80	83	79	72	61	90-8-2	46	67	74	79	82	78	71	60
90-8-5,5	48	69	76	81	84	80	73	62	90-8-5,5	45	66	73	78	81	77	70	59
90-8-7,5	50	71	78	83	86	82	75	64	90-8-7,5	47	68	75	80	83	79	72	61
90-8-9	51	72	79	84	87	83	76	65	90-8-9	48	69	76	81	84	80	73	62

Acoustic features

Values taken at inlet with maximum airflow.

Values taken at outlet with maximum airflow.

Sound power Lw(A) spectrum in dB(A) via frequency band in Hz.

Modelo	63	125	250	500	1000	2000	4000	8000
90-12-3	37	58	65	70	73	69	62	51
90-12-4	38	59	66	71	74	70	63	52
100-4-7,5	68	89	96	101	104	100	93	82
100-4-9	68	89	96	101	104	100	93	82
100-4-10	69	90	97	102	105	101	94	83
100-4-14	69	90	97	102	105	101	94	83
100-4-15	70	91	98	103	106	102	95	84
100-6-3	58	79	86	91	94	90	83	72
100-6-4	59	80	87	92	95	91	84	73
100-6-5,5	60	81	88	93	96	92	85	74
100-8-3	53	74	81	86	89	85	78	67
100-8-4	54	75	82	87	90	86	79	68
100-8-7,5	53	74	81	86	89	85	78	67
100-8-9	53	74	81	86	89	85	78	67
100-8-14	54	75	82	87	90	86	79	68
100-12-3	43	64	71	76	79	75	68	57
100-12-4	44	65	72	77	80	76	69	58
100-12-5,5	45	66	73	78	81	77	70	59
125-4T/3-10	66	73	84	94	95	90	82	78
125-4T/3-15	67	74	85	95	96	91	83	79
125-4T/3-20	69	76	87	97	98	93	85	81
125-4T/6-15	63	72	87	94	97	91	85	81
125-4T/6-20	63	72	87	94	97	91	85	81
125-4T/9-20	62	71	87	93	95	89	84	80
125-6T/6-5,5	56	66	78	81	83	79	68	64
125-6T/6-7,5	56	66	78	81	83	79	68	64
125-6T/6-10	58	68	80	83	85	81	70	66
125-6T/6-15	60	70	82	85	87	83	72	68
125-6T/9-7,5	54	65	79	83	83	81	70	66
125-6T/9-10	54	65	79	83	83	81	70	66
125-6T/9-15	57	68	82	86	86	84	73	69
125-6T/9-20	60	71	85	89	89	87	76	72
125-8T/6-4	50	59	70	75	75	69	58	54
125-8T/6-5,5	52	61	72	77	77	71	60	56
125-8T/6-7,5	54	63	74	79	79	73	62	58
125-8T/6-10	55	64	75	80	80	74	63	59
125-8T/9-5,5	49	61	70	76	78	72	61	57
125-8T/9-7,5	52	64	73	79	81	75	64	60
125-8T/9-10	54	66	75	81	83	77	66	62
125-8T/9-15	55	67	76	82	84	78	67	63

Modelo	63	125	250	500	1000	2000	4000	8000
90-12-3	35	56	63	68	71	67	60	49
90-12-4	36	57	64	69	72	68	61	50
100-4-7,5	65	86	93	98	101	97	90	79
100-4-9	65	86	93	98	101	97	90	79
100-4-10	66	87	94	99	102	98	91	80
100-4-14	66	87	94	99	102	98	91	80
100-4-15	67	88	95	100	103	99	92	81
100-6-3	56	77	84	89	92	88	81	70
100-6-4	57	78	85	90	93	89	82	71
100-6-5,5	58	79	86	91	94	90	83	72
100-8-3	52	73	80	85	88	84	77	66
100-8-4	53	74	81	86	89	85	78	67
100-8-7,5	50	71	78	83	86	82	75	64
100-8-9	50	71	78	83	86	82	75	64
100-8-14	51	72	79	84	87	83	76	65
100-12-3	41	62	69	74	77	73	66	55
100-12-4	42	63	70	75	78	74	67	56
100-12-5,5	43	64	71	76	79	75	68	57
125-4T/3-10	63	70	81	91	92	87	79	75
125-4T/3-15	64	71	82	92	93	88	80	76
125-4T/3-20	66	73	84	94	95	90	82	78
125-4T/6-15	60	69	84	91	94	88	82	78
125-4T/6-20	60	69	84	91	94	88	82	78
125-4T/9-20	59	68	84	90	92	86	81	77
125-6T/6-5,5	54	64	76	79	81	77	66	62
125-6T/6-7,5	54	64	76	79	81	77	66	62
125-6T/6-10	56	66	78	81	83	79	68	64
125-6T/6-15	58	68	80	83	85	81	70	66
125-6T/9-7,5	52	63	77	81	81	79	68	64
125-6T/9-10	52	63	77	81	81	79	68	64
125-6T/9-15	55	66	80	84	84	82	71	67
125-6T/9-20	58	69	83	87	87	85	74	70
125-8T/6-4	49	58	69	74	74	68	57	53
125-8T/6-5,5	51	60	71	76	76	70	59	55
125-8T/6-7,5	53	62	73	78	78	72	61	57
125-8T/6-10	54	63	74	79	79	73	62	58
125-8T/9-5,5	48	60	69	75	77	71	60	56
125-8T/9-7,5	51	63	72	78	80	74	63	59
125-8T/9-10	53	65	74	80	82	76	65	61
125-8T/9-15	54	66	75	81	83	77	66	62

Dimensions in mm

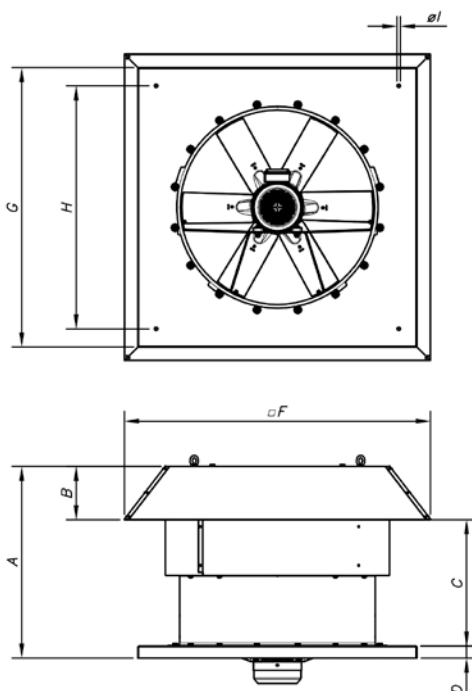

Model	A	B	C	D	F	G	H	I
HTMF-56	650	185	425	40	963	900	750	14
HTMF-63	680	215	425	40	1093	1000	850	14
HTMF-71	760	195	525	40	1223	1000	850	14
HTMF-80	790	220	520	50	1263	1150	1000	14
HTMF-90	910	232	638	50	1380	1150	1000	14
HTMF-100	1025	262	713	50	1525	1250	1100	14
HTMF-125	1170	310	859	50	1802	1600	1450	17

Characteristic curves

Q = Airflow in m³/h, m³/s and cfm.

Pe= Static pressure in mmH₂O, Pa and inwg.

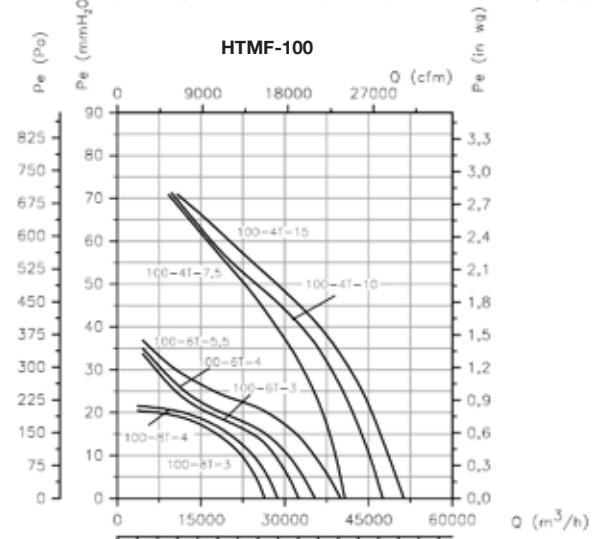
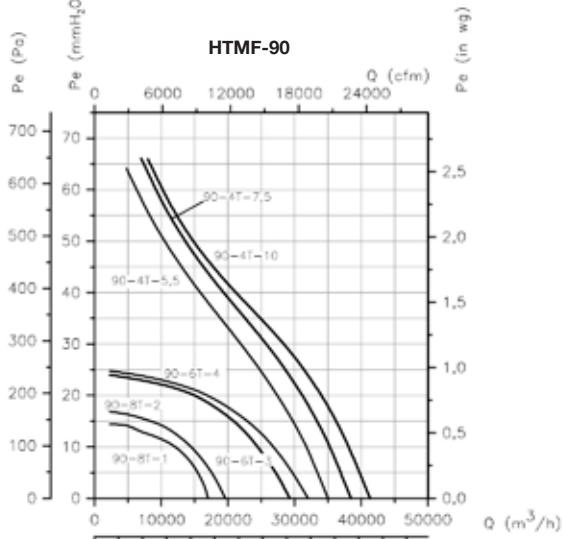
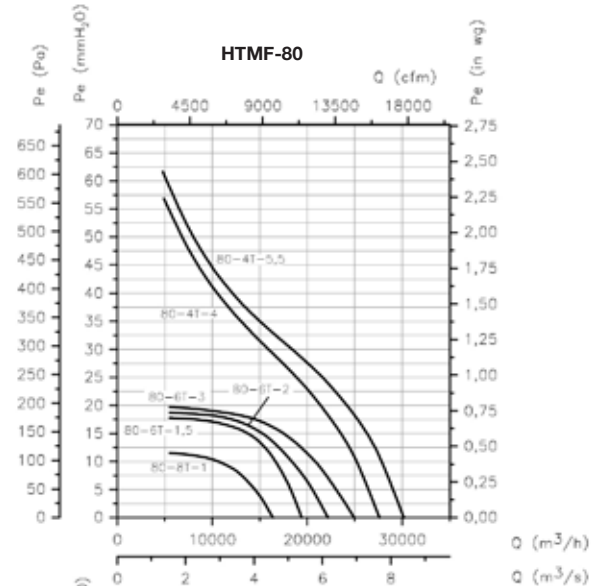
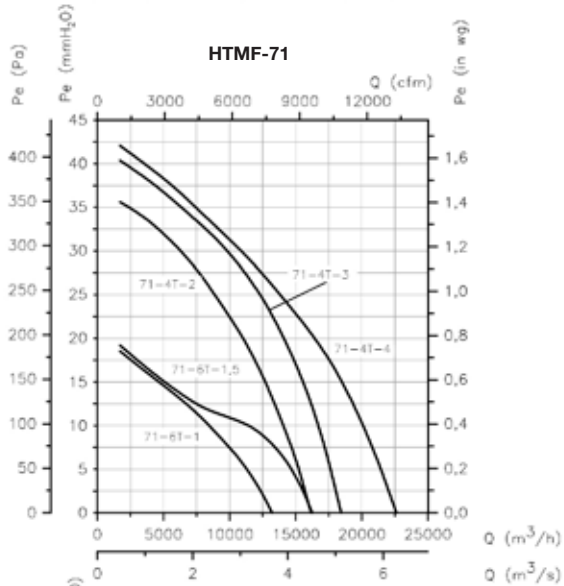
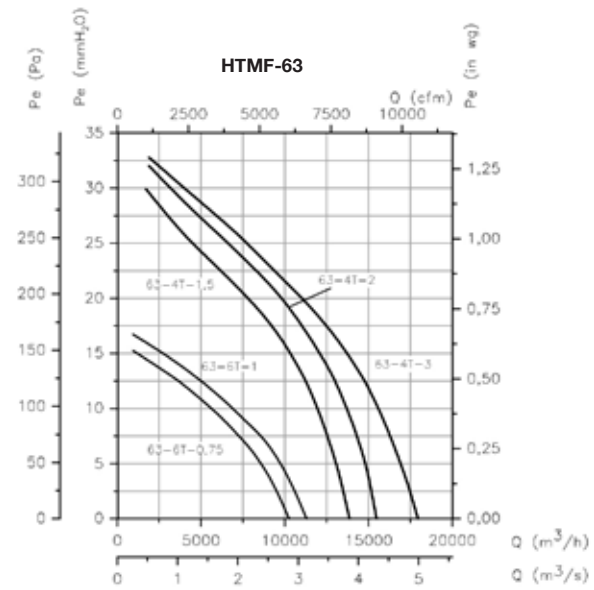
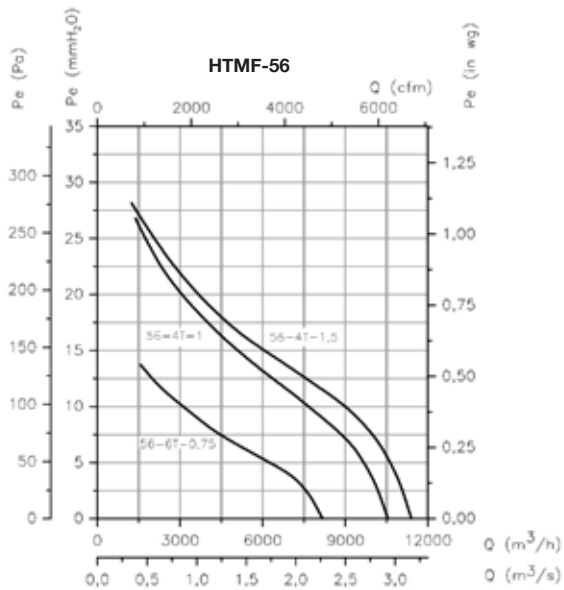

Characteristic curves

Q = Airflow in m³/h, m³/s and cfm.

Pe= Static pressure in mmH₂O, Pa and inwg.

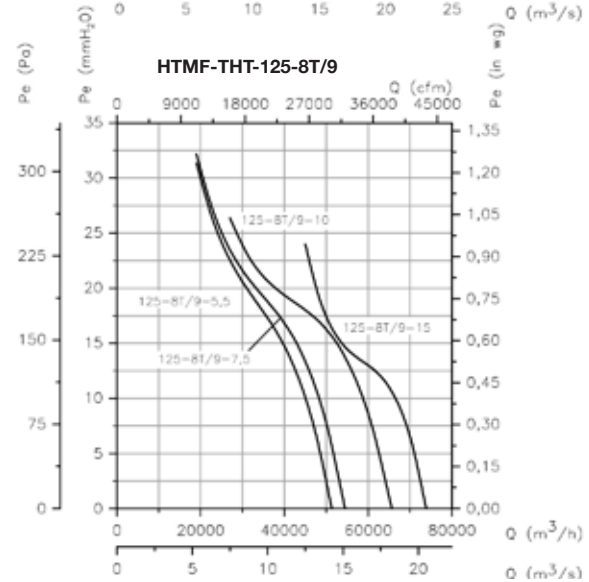
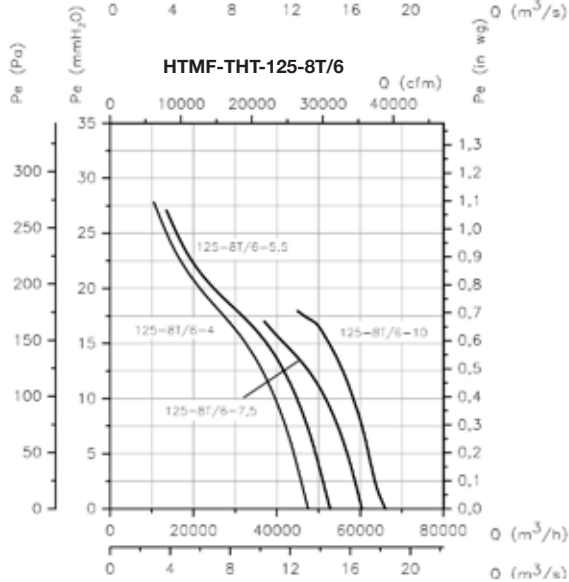
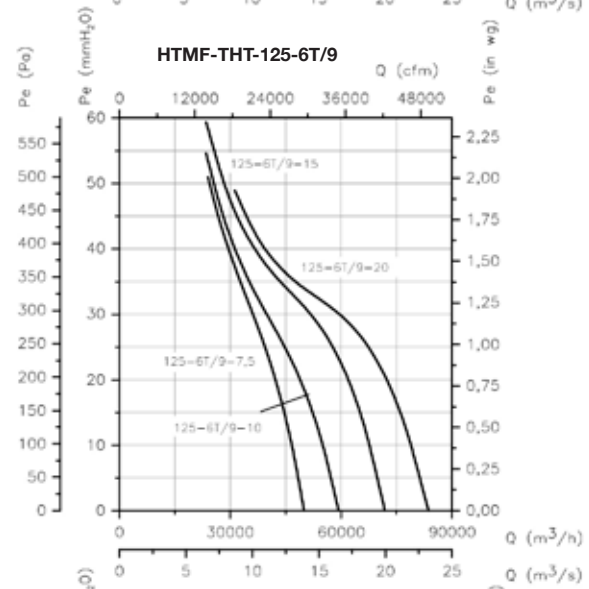
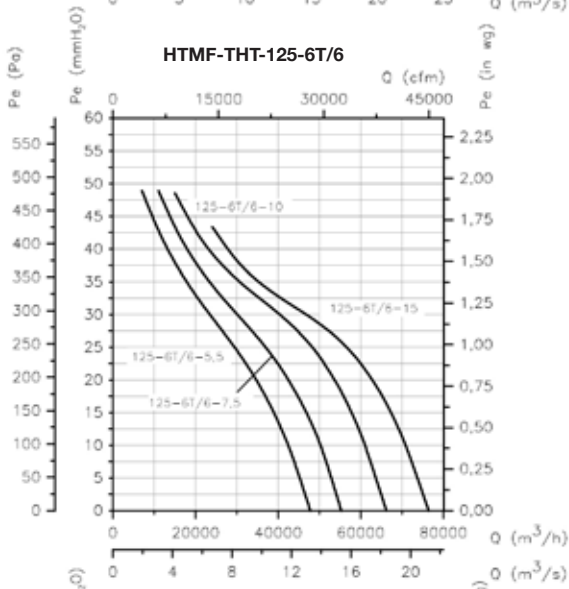
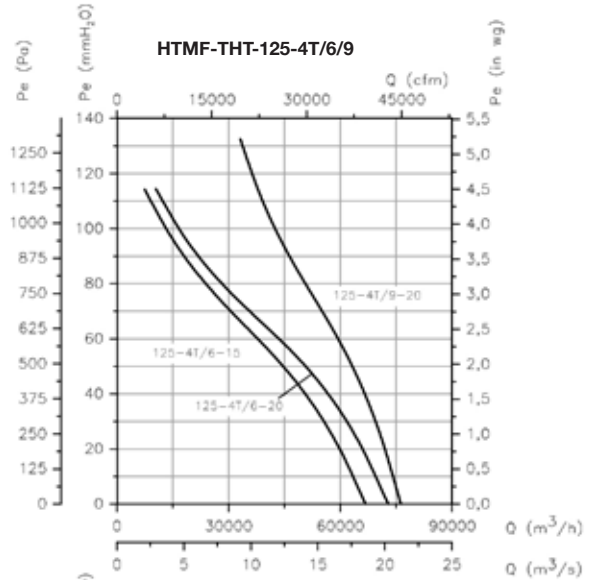
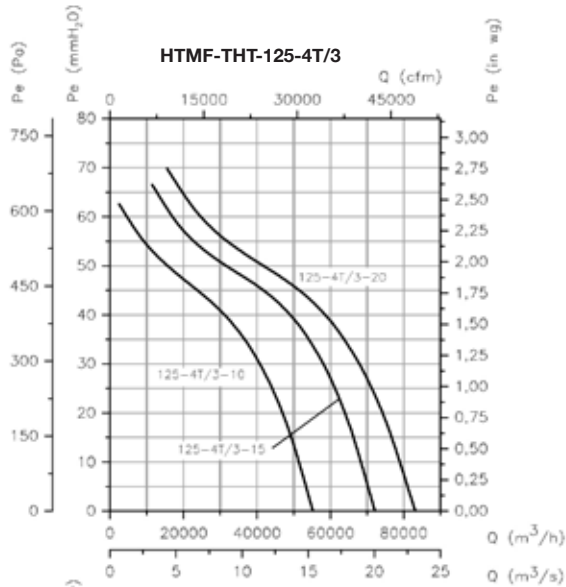

Validation of the sound pressure according to distance

The sound level may vary depending on the structure of the roof.

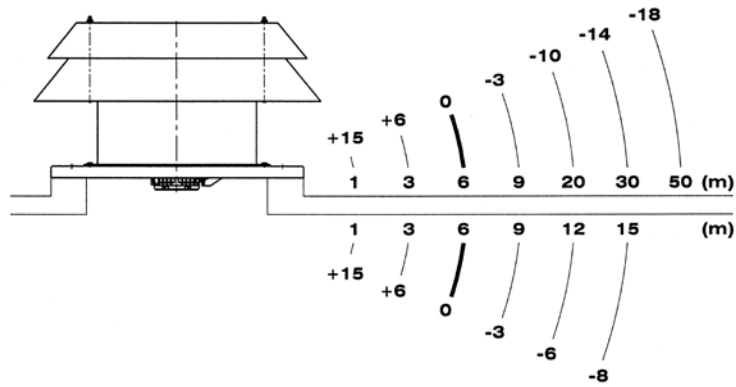

Accessories

See accessories section

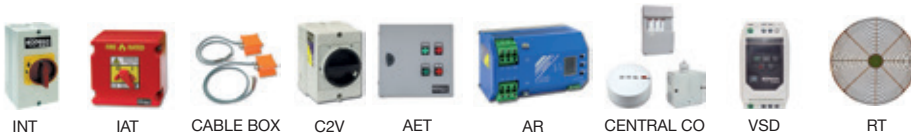

INT IAT CABLE BOX C2V AET AR CENTRAL CO VSD RT